

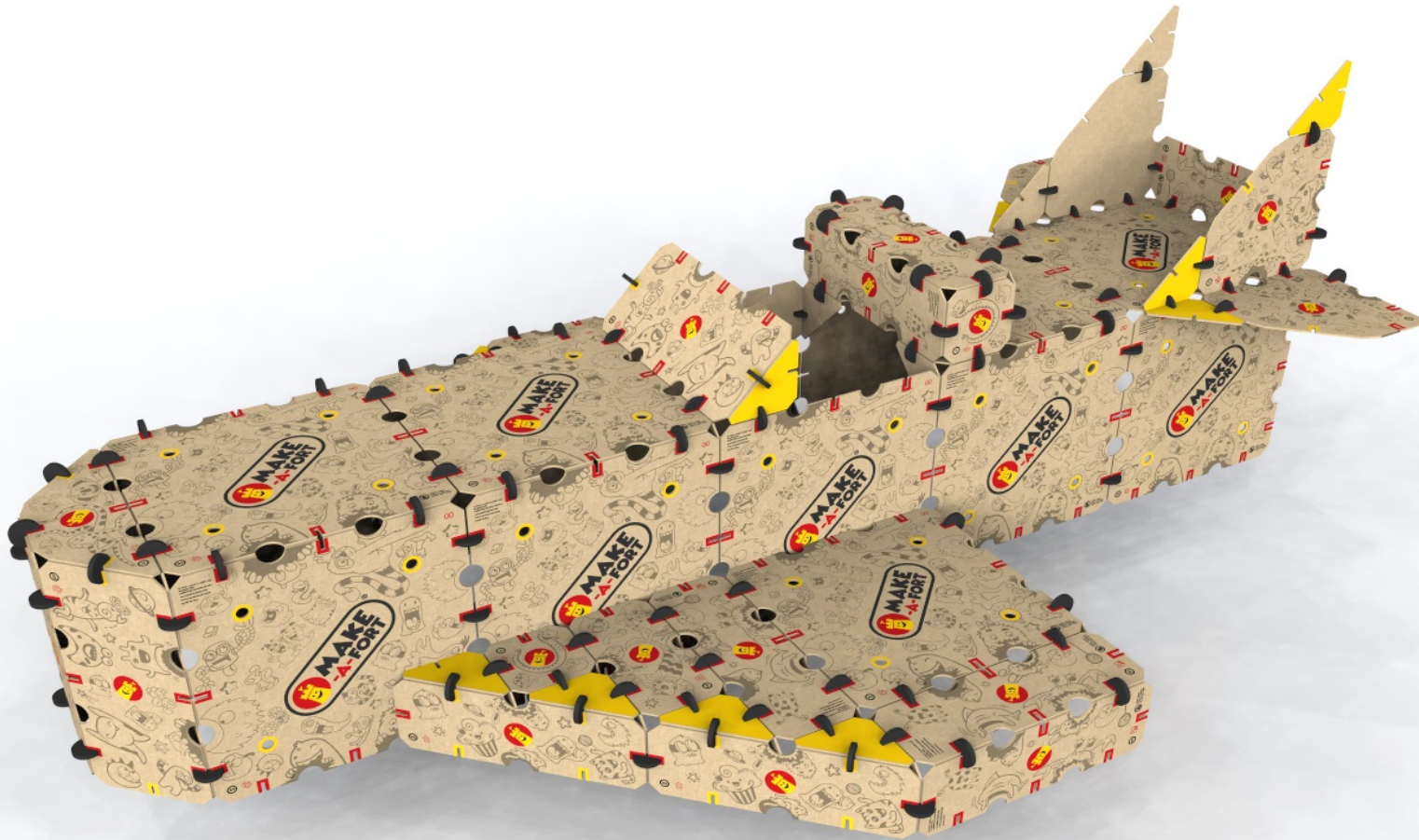

## Project - Jet



Structure is not rigid and will flex when bumped

Requires 1 x Explorer Kit and 1 x Creator Kit. Recommend two persons ages 10 and up. Takes one to two hours to build.

1

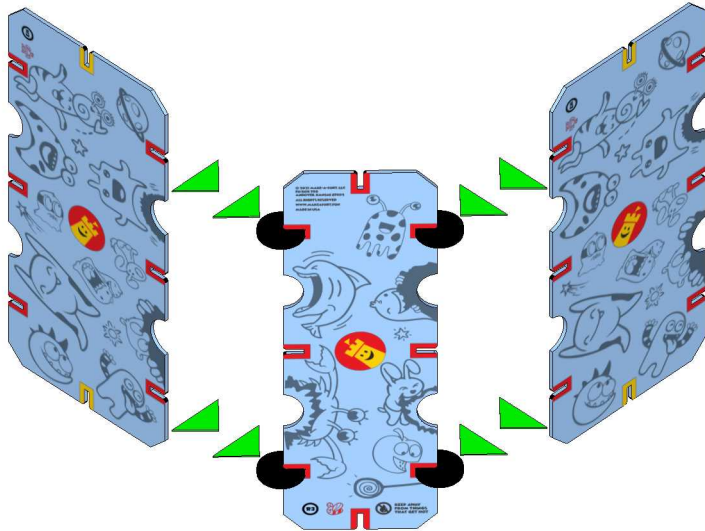

H3 x 2  
R3 x 1  
C x 4

2

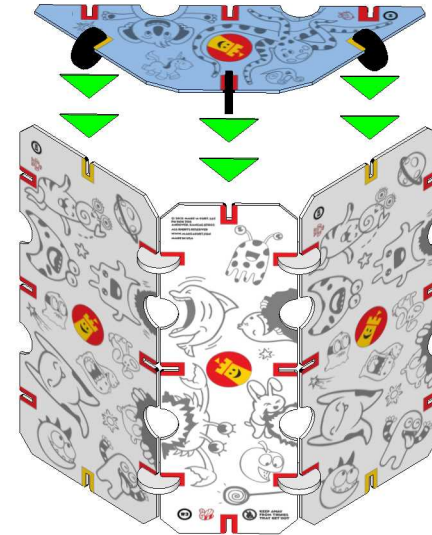

Z x 1  
C x 3

3

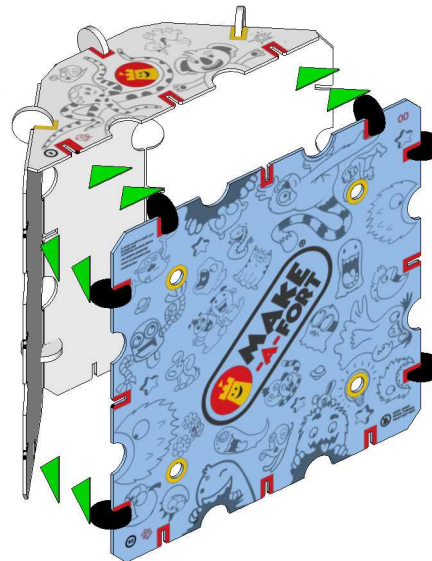

S3 x 1  
C x 6

4

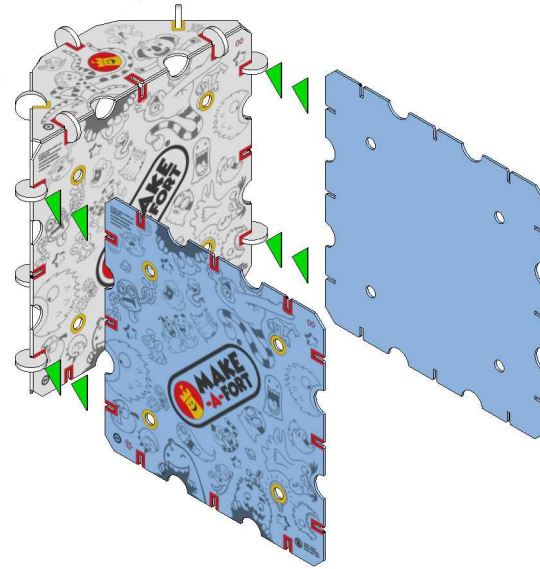

S3 x 2

5

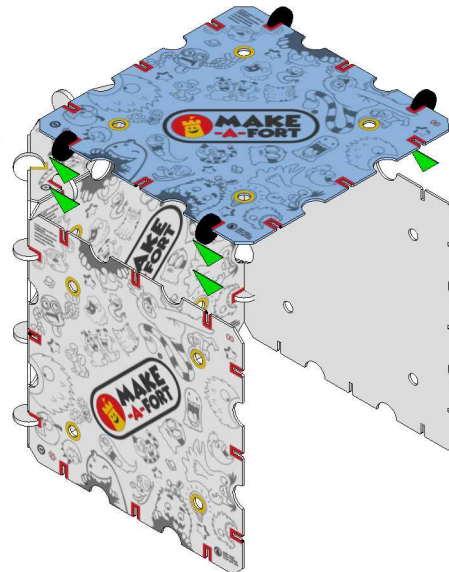

S3 x 1  
C x 4



# Project - Jet

## Build Nose



6

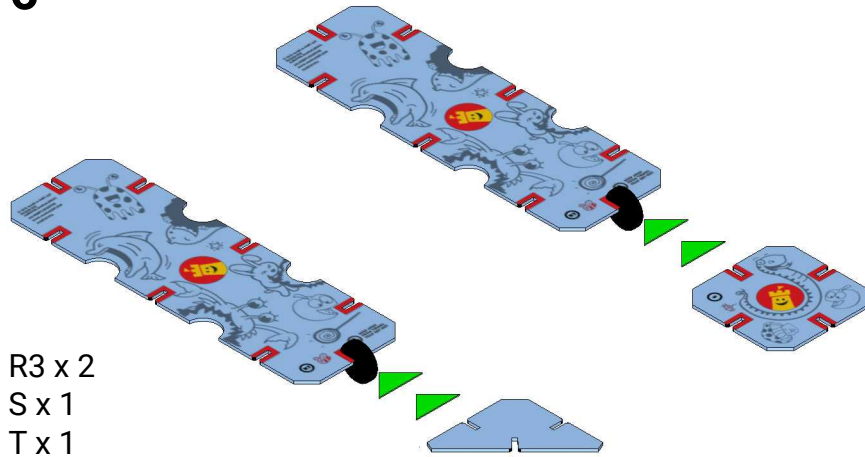

R3 x 2  
S x 1  
T x 1  
C x 2

7

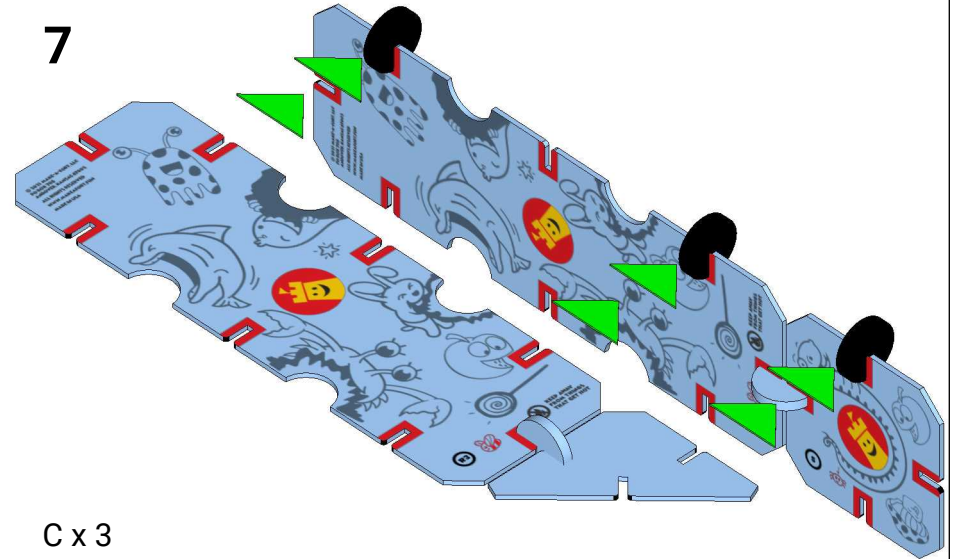

C x 3

8

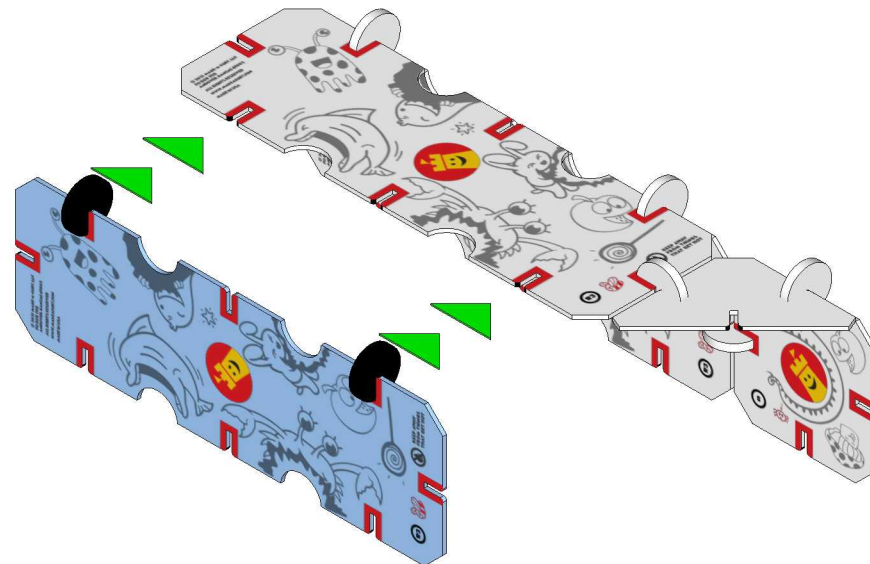

R3 x 1  
C x 2

9

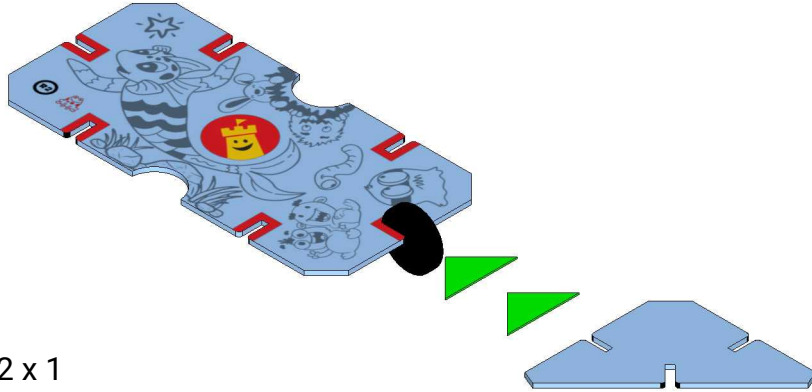

R2 x 1  
T x 1  
C x 1

10

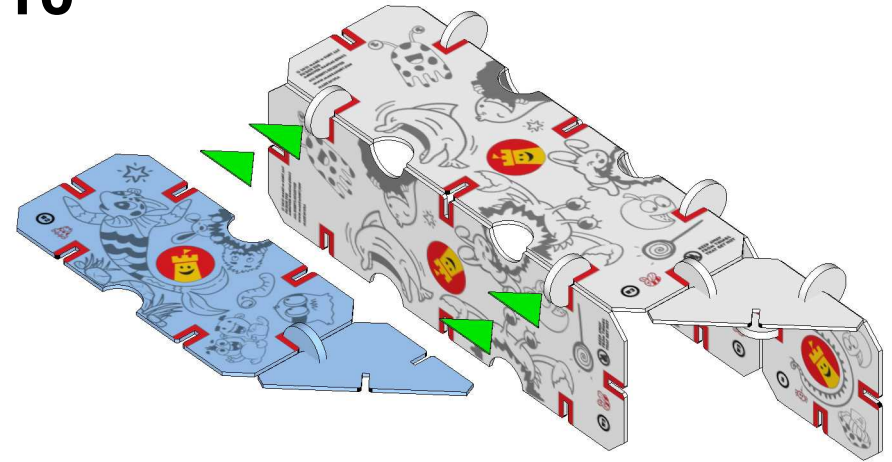

11

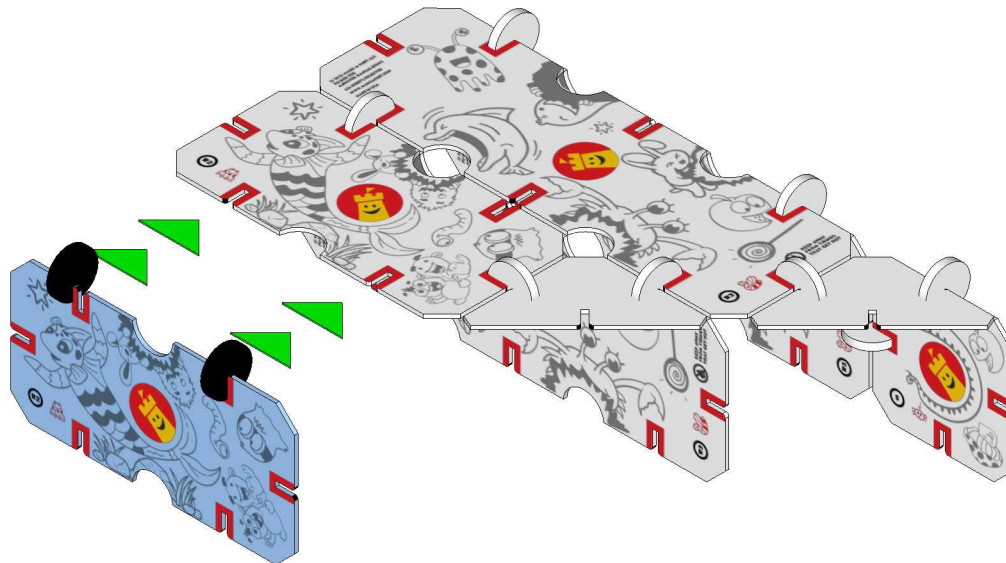

R2 x 1  
C x 2

**12**

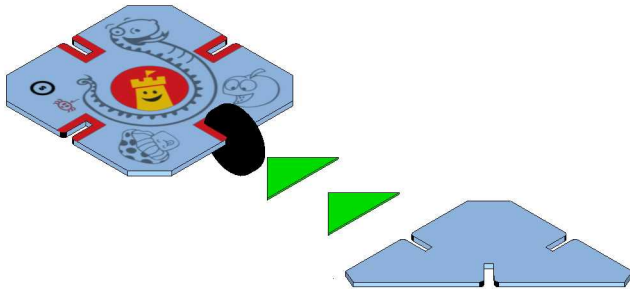

S x 1  
T x 1  
C x 1

**13**

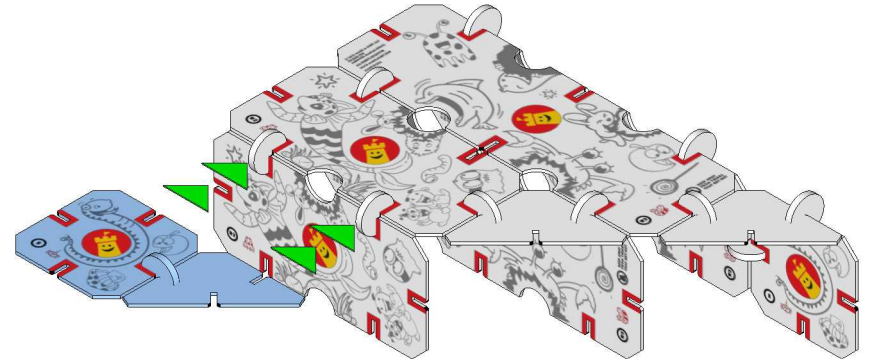

**14**

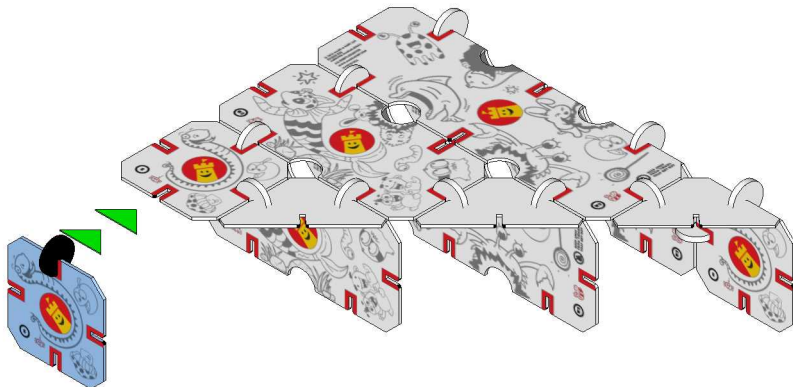

S x 1  
C x 1

**15**

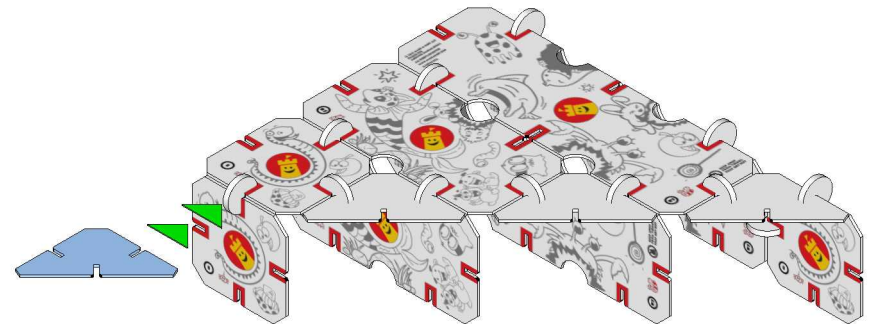

T x 1

# 16

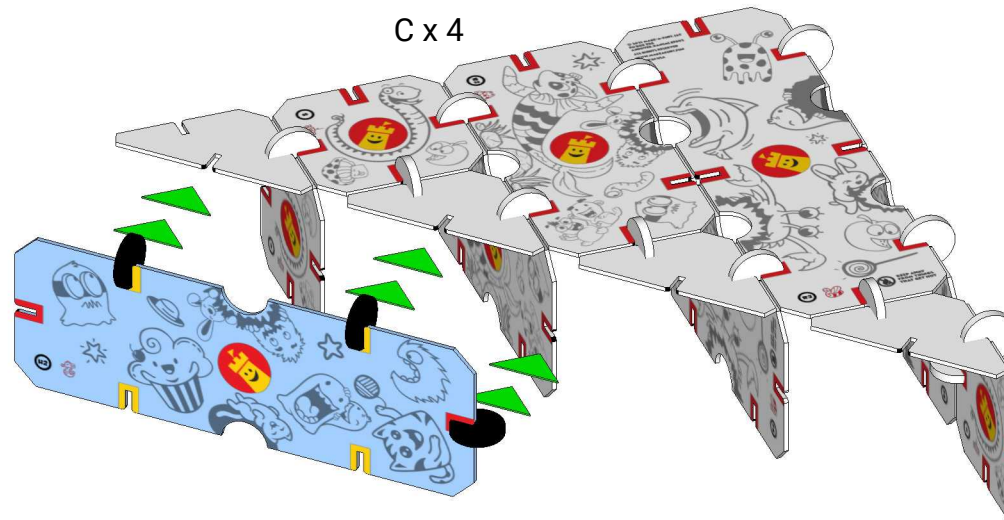

H2 x 1  
C x 3

# 17

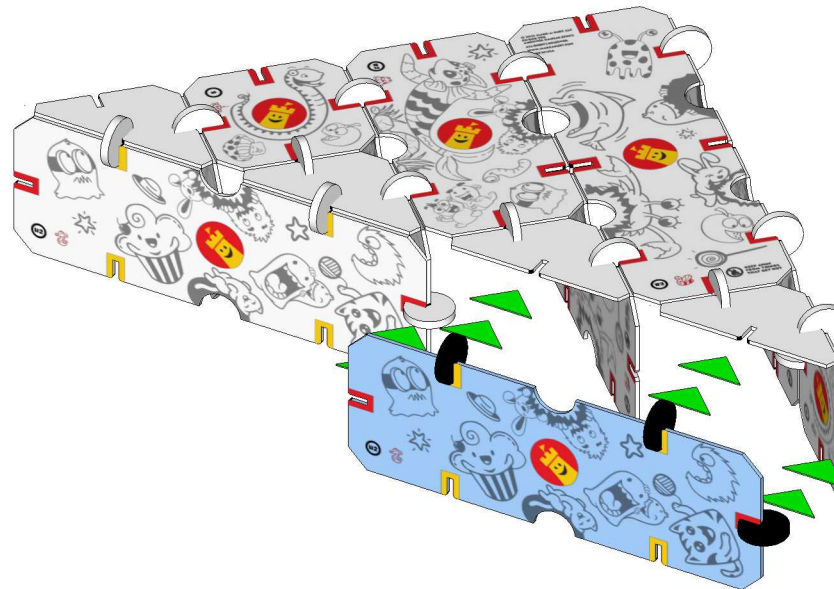

H2 x 1  
C x 3



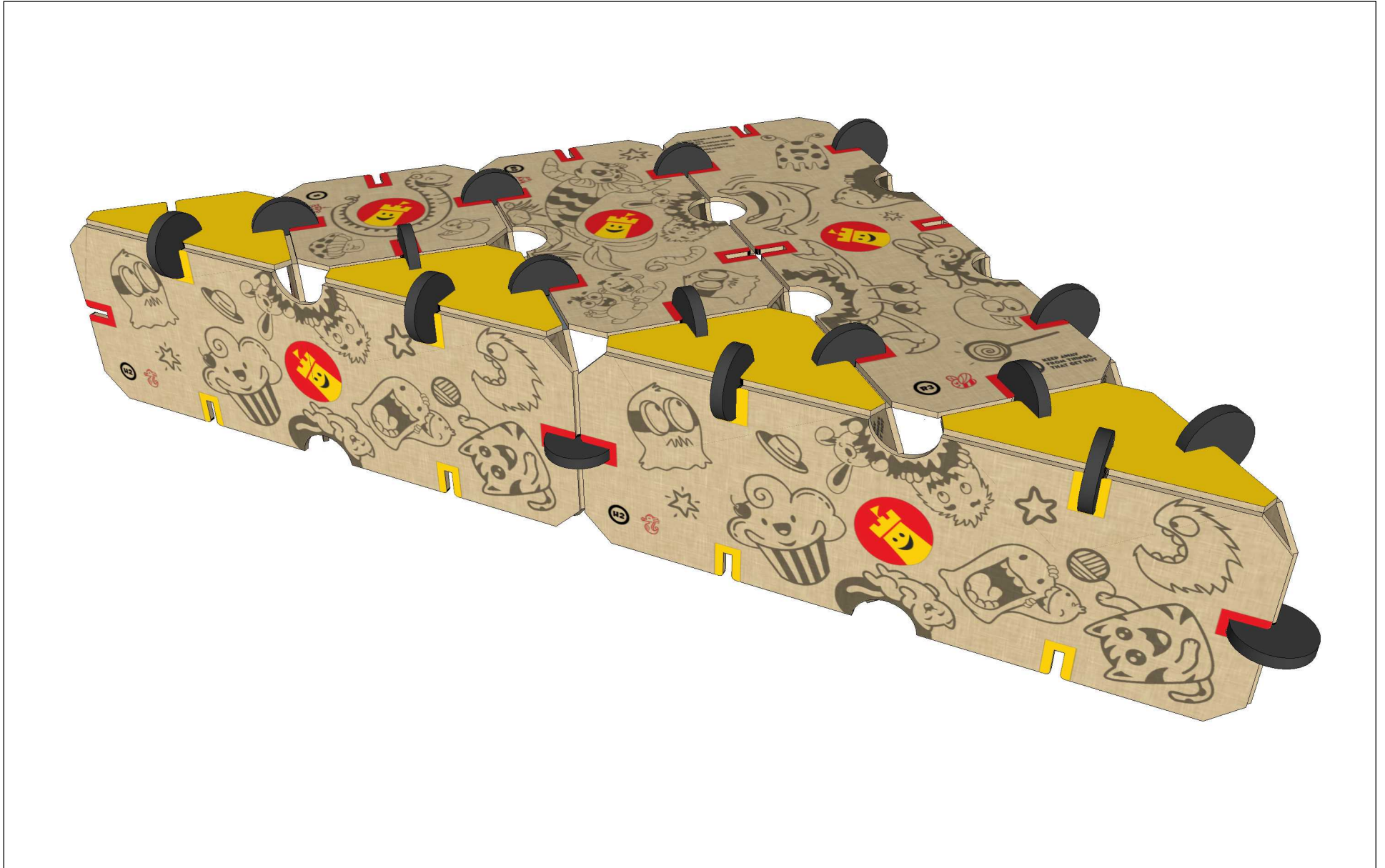

18

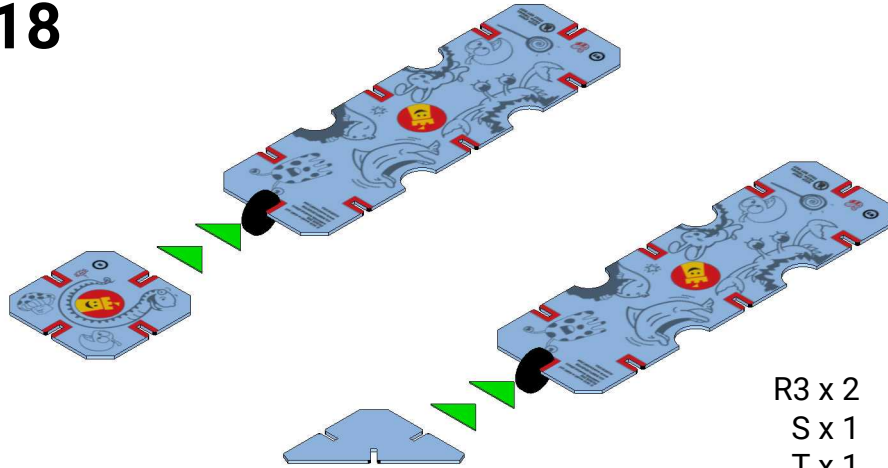

R3 x 2  
S x 1  
T x 1  
C x 2

19

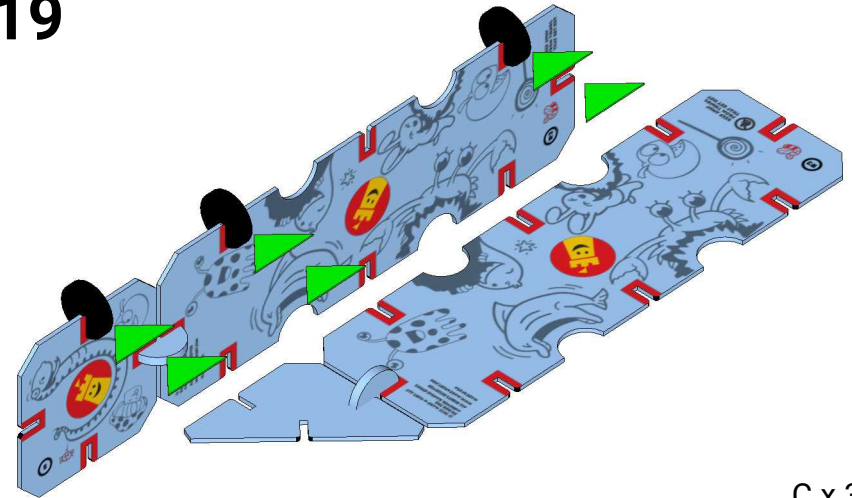

C x 3

20

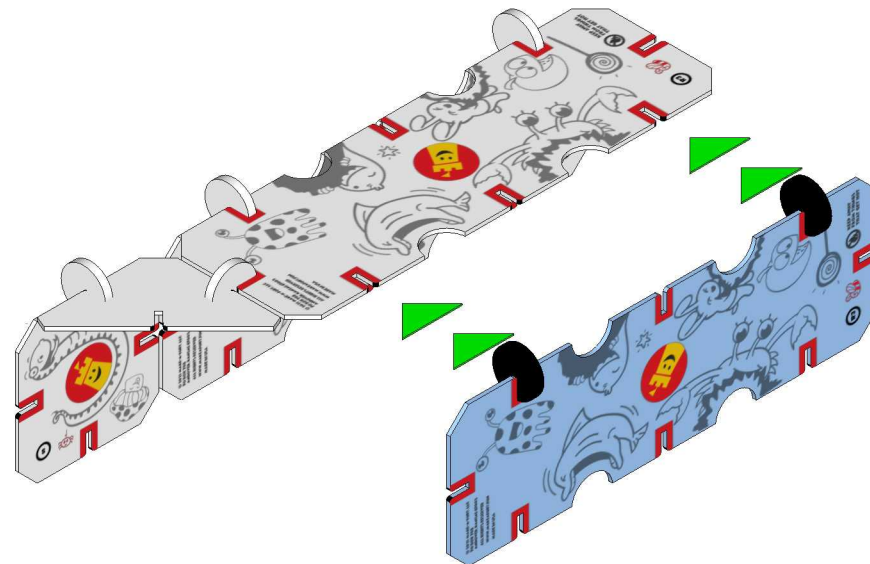

R3 x 1  
C x 2

21

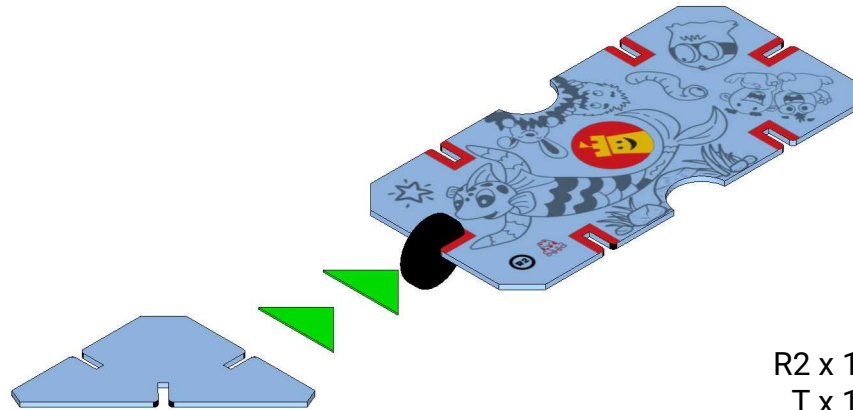

R2 x 1  
T x 1  
C x 1

22

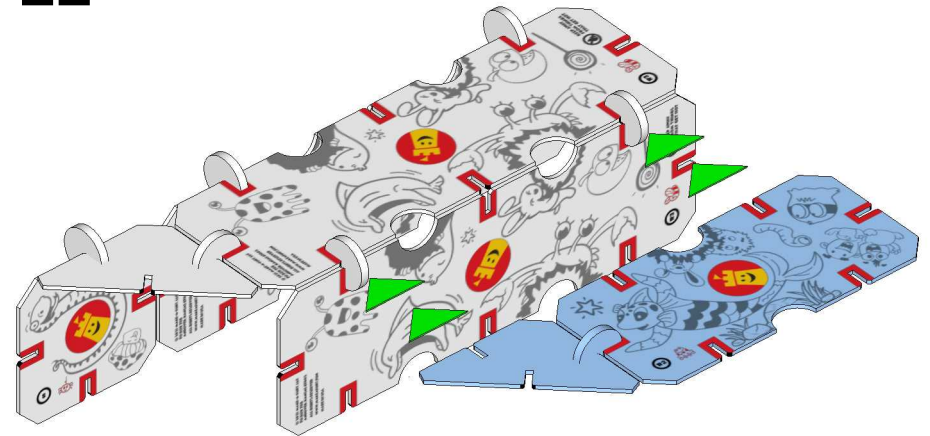

23

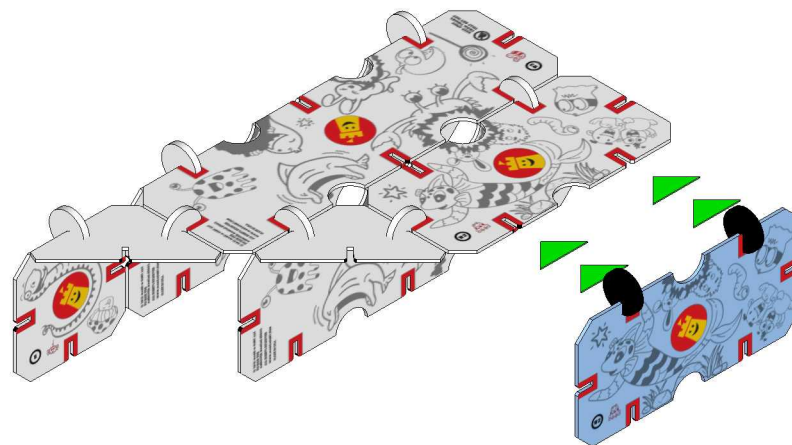

R2 x 1  
C x 2

24

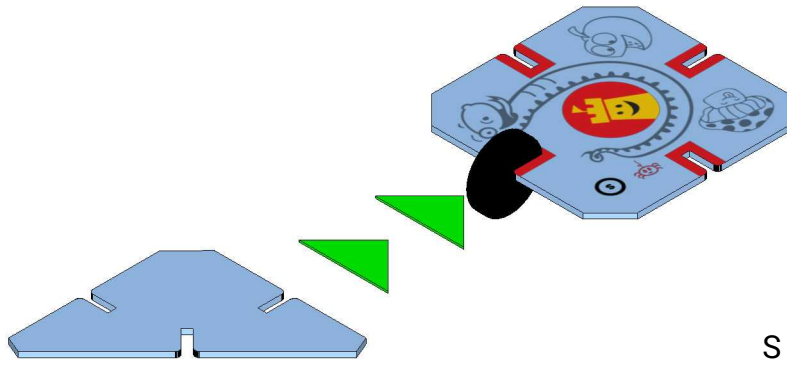

S x 1  
T x 1  
C x 1

25

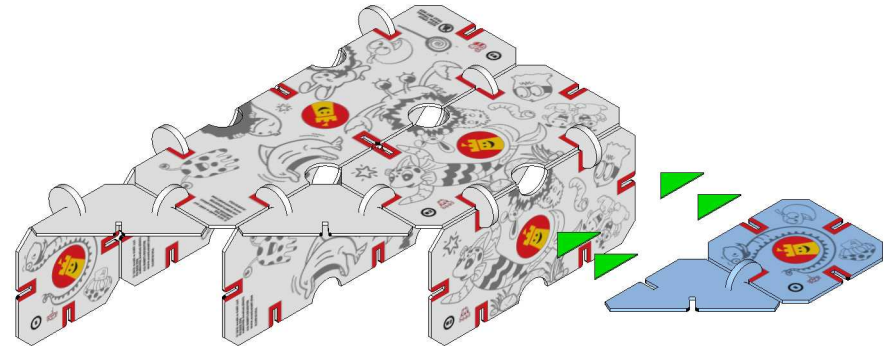

26

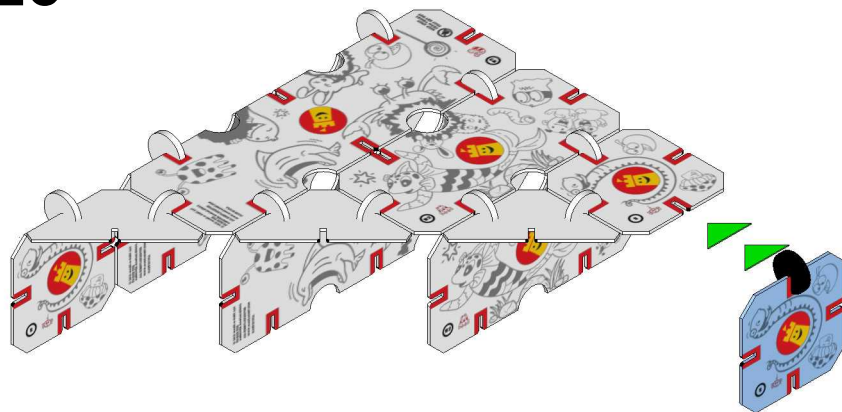

S x 1  
C x 1

27

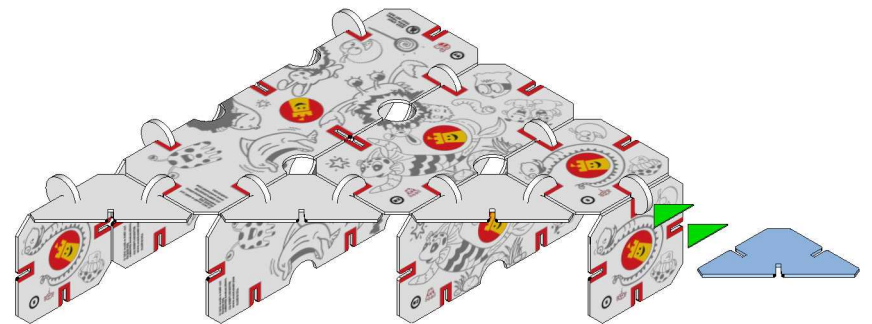

T x 1

## 28

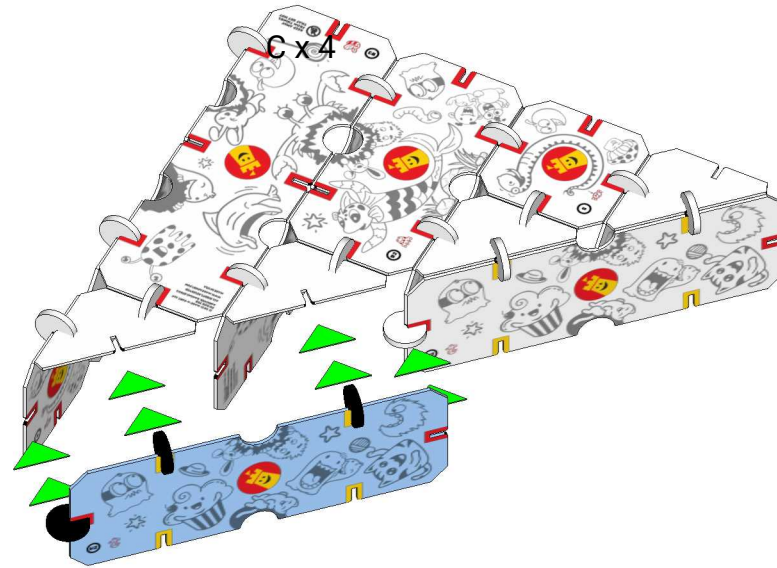

H2 x 1  
C x 3

## 29

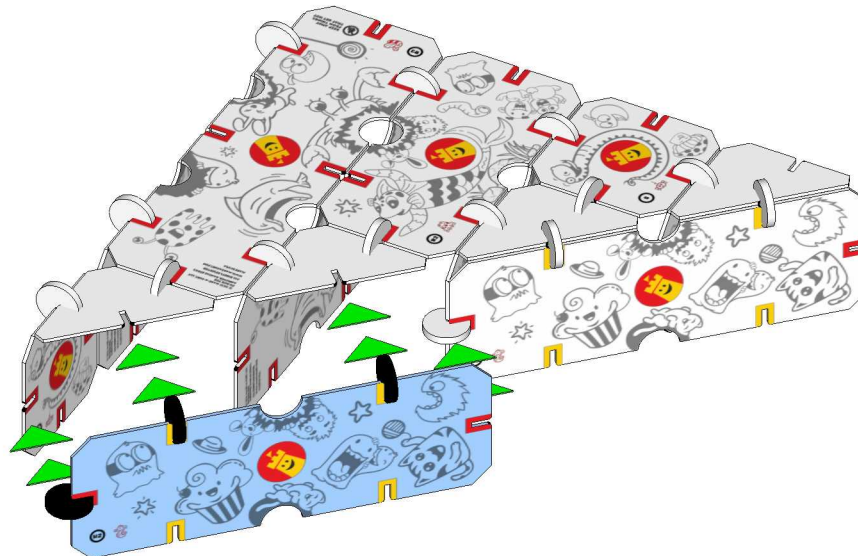

H2 x 1  
C x 3



30

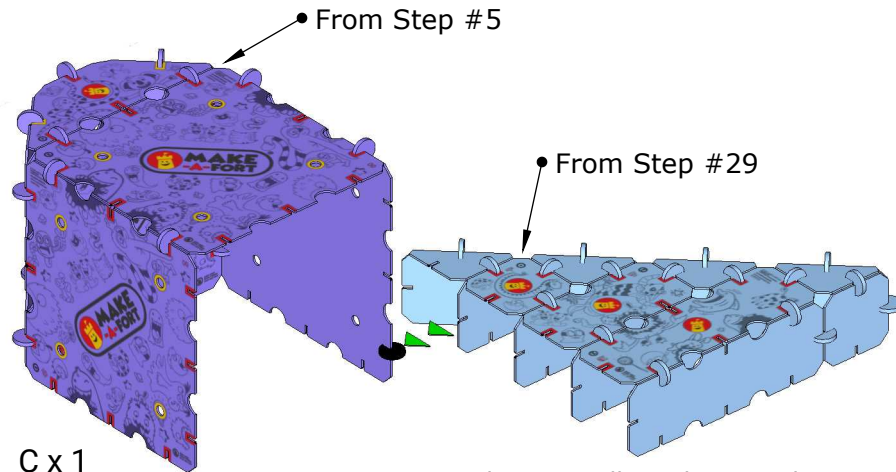

C x 1

**Note:** Right wing will overlap nose by 1 unit

31

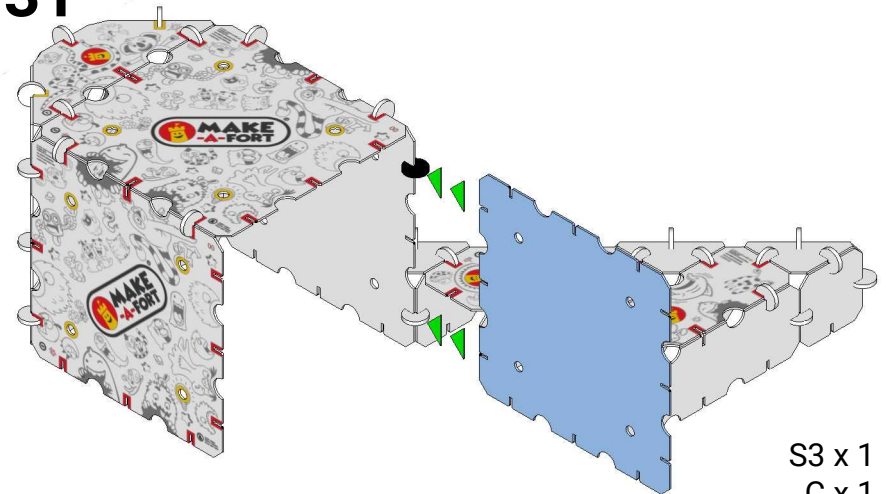

S3 x 1  
C x 1

32

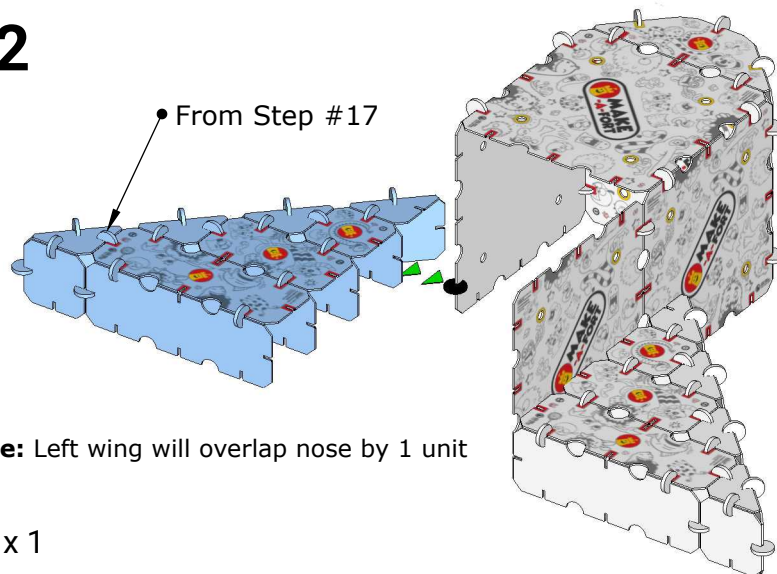

**Note:** Left wing will overlap nose by 1 unit

C x 1

33

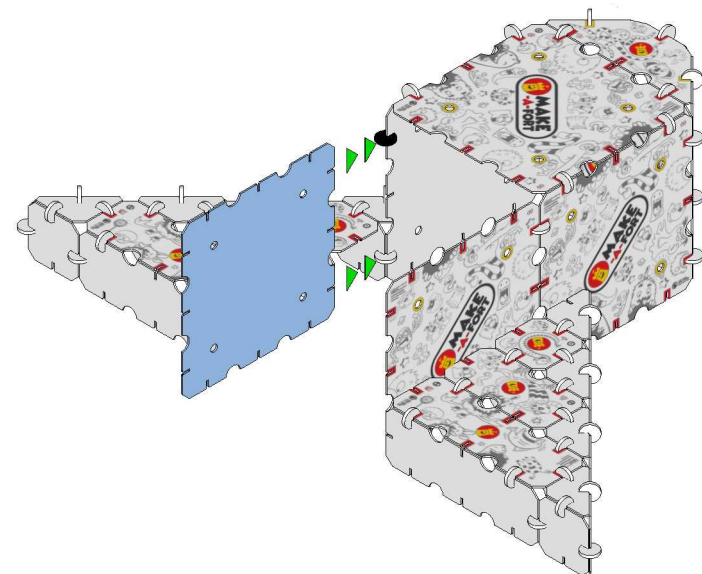

S3 x 1  
C x 1

**34**

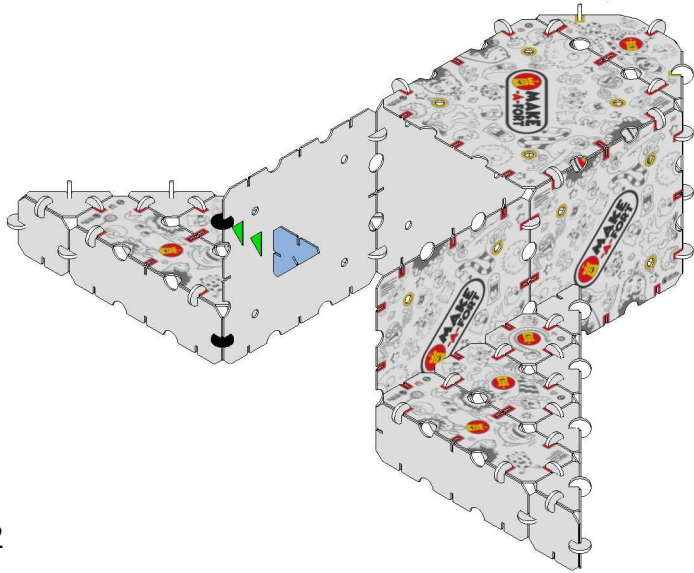

T x 1  
C x 2

**35**

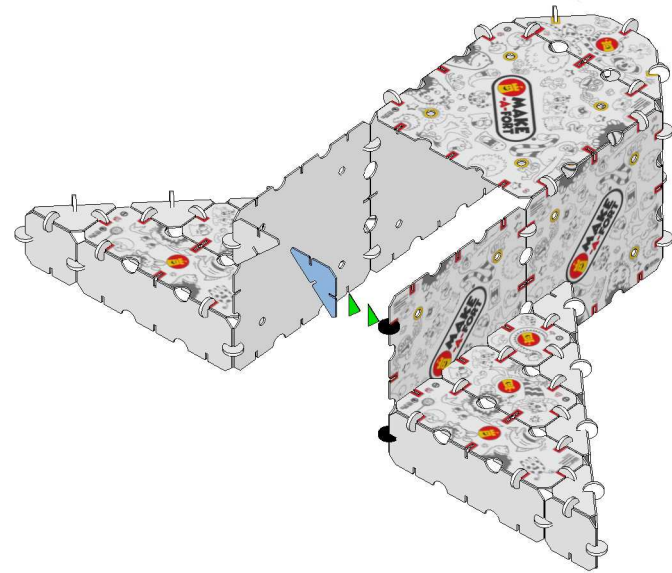

T x 1  
C x 2

**36**

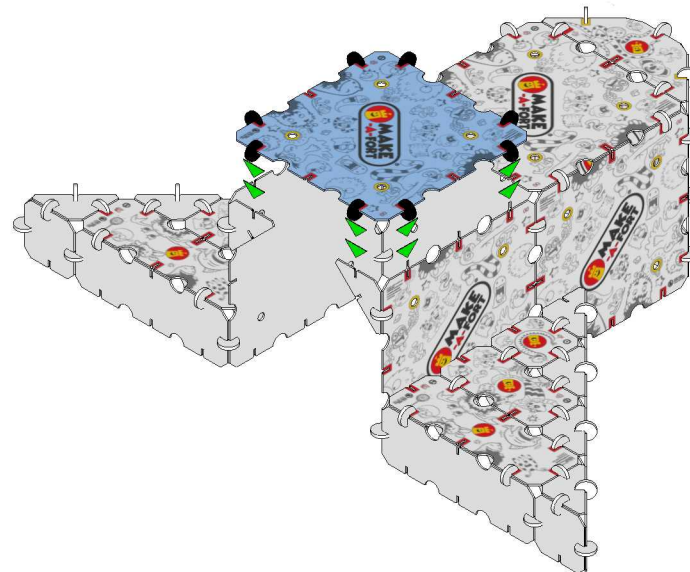

S3 x 1  
C x 8





# Project - Jet

## Front Fuselage

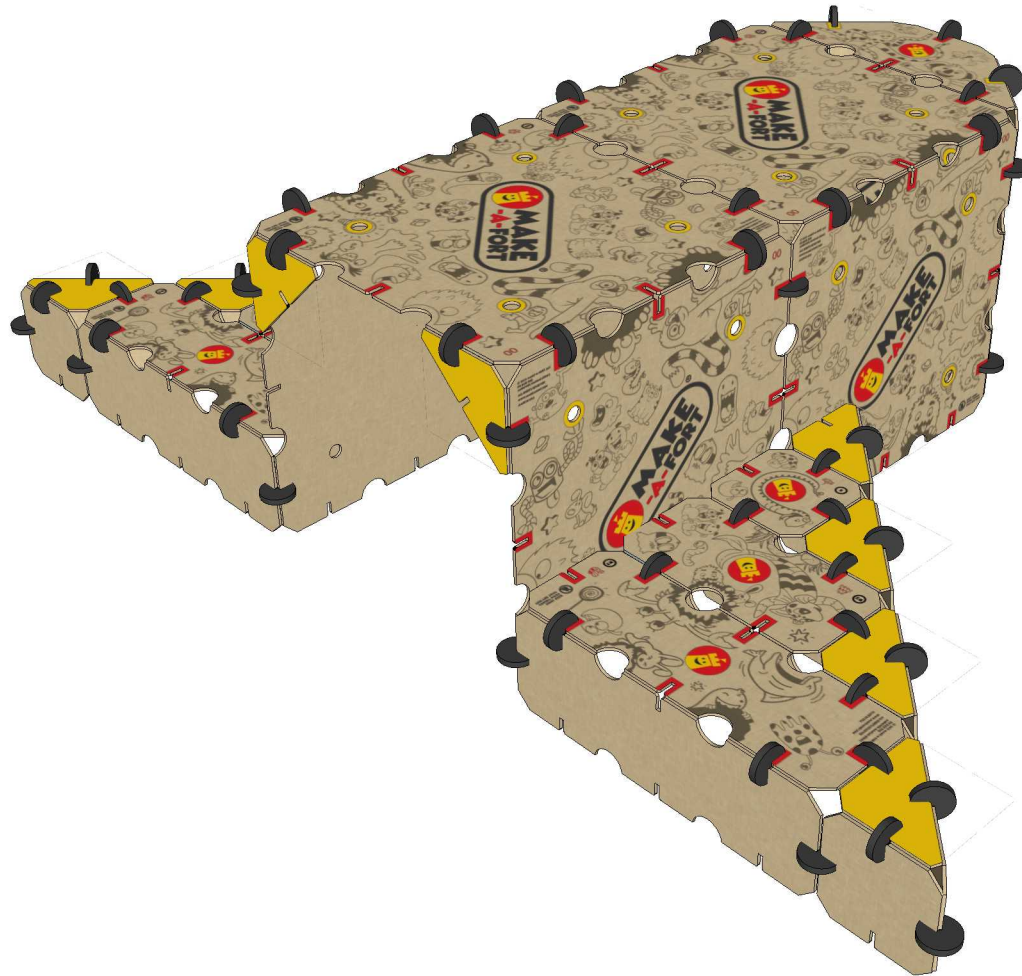

**37**

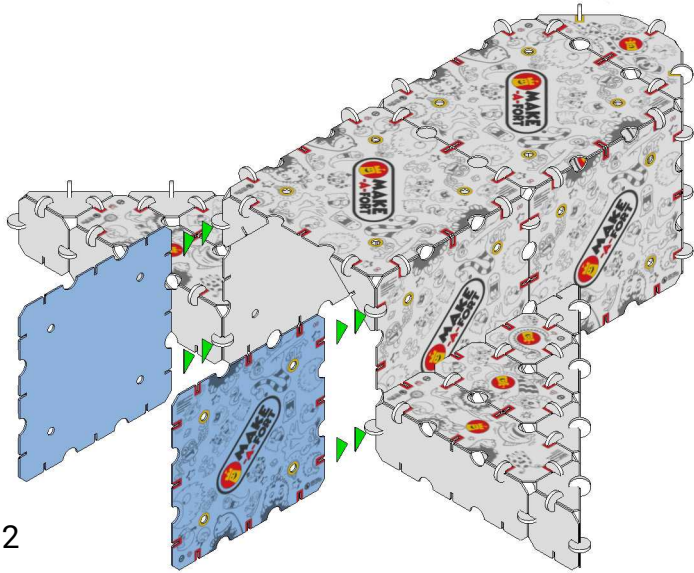

S3 x 2

**38**

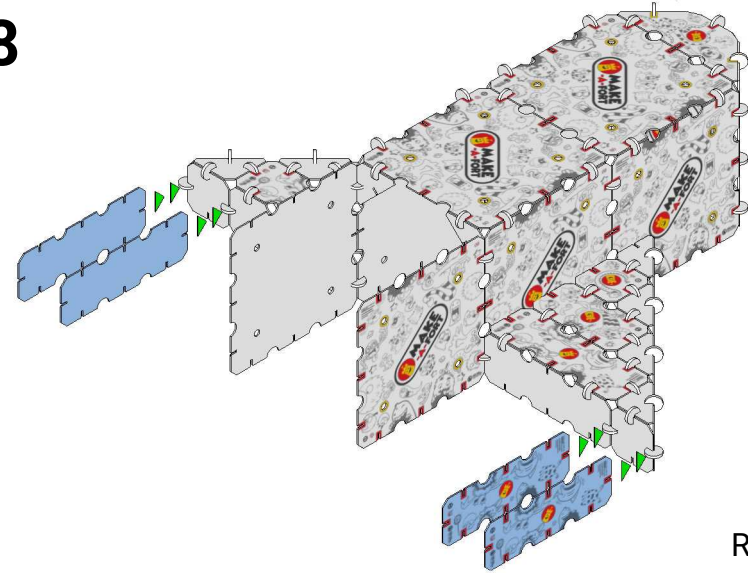

R3 x 4

**39**

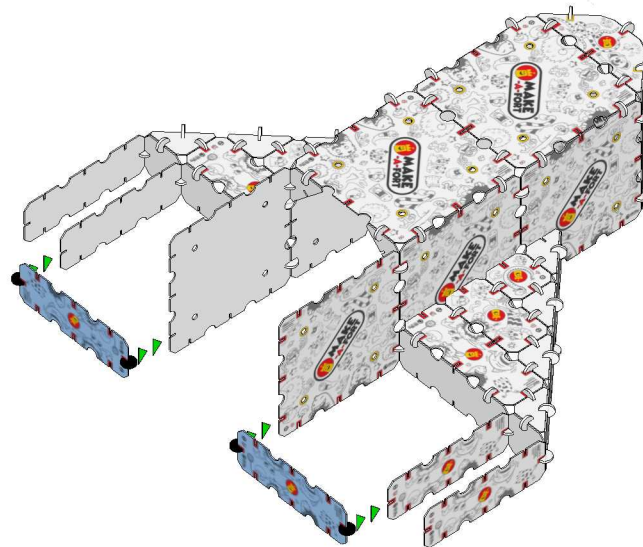

R3 x 2  
C x 4

40

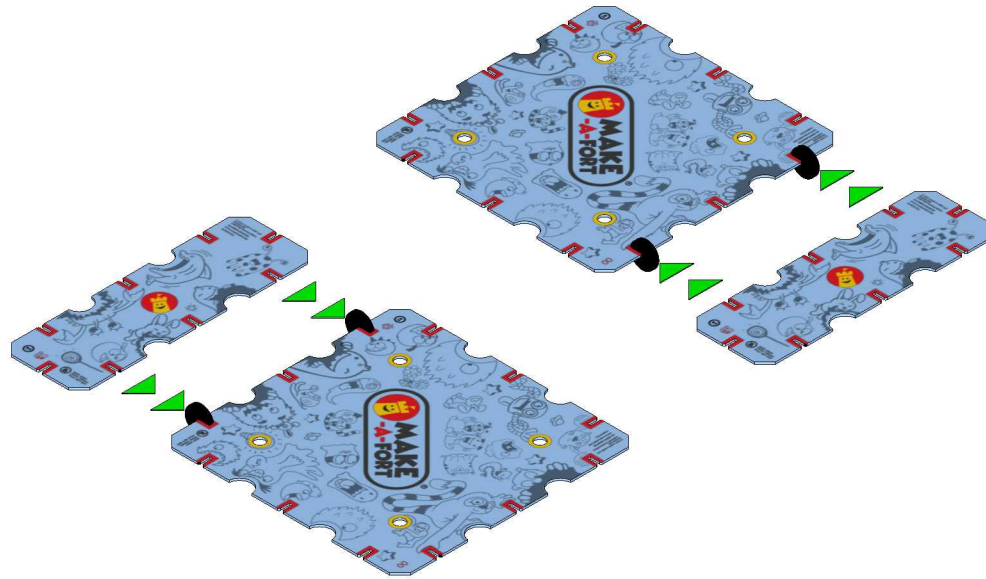

S3 x 2  
R3 x 2  
C x 4

41

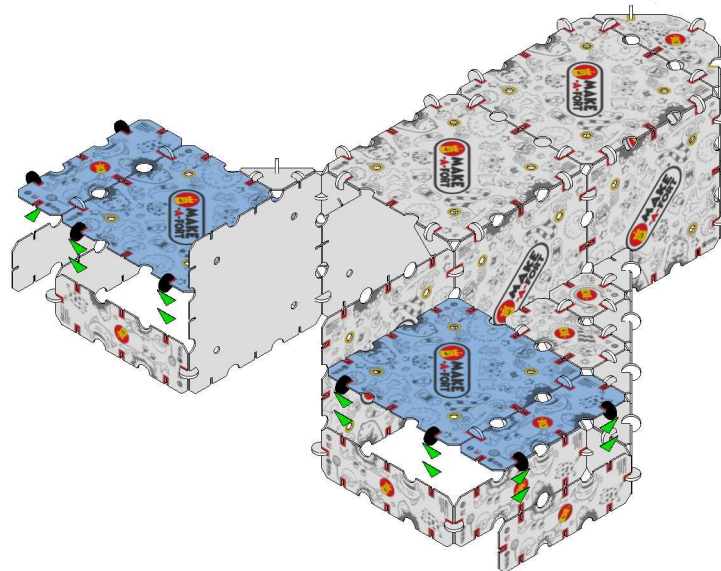

C x 8



# Project - Jet

## Build Mid Fuselage

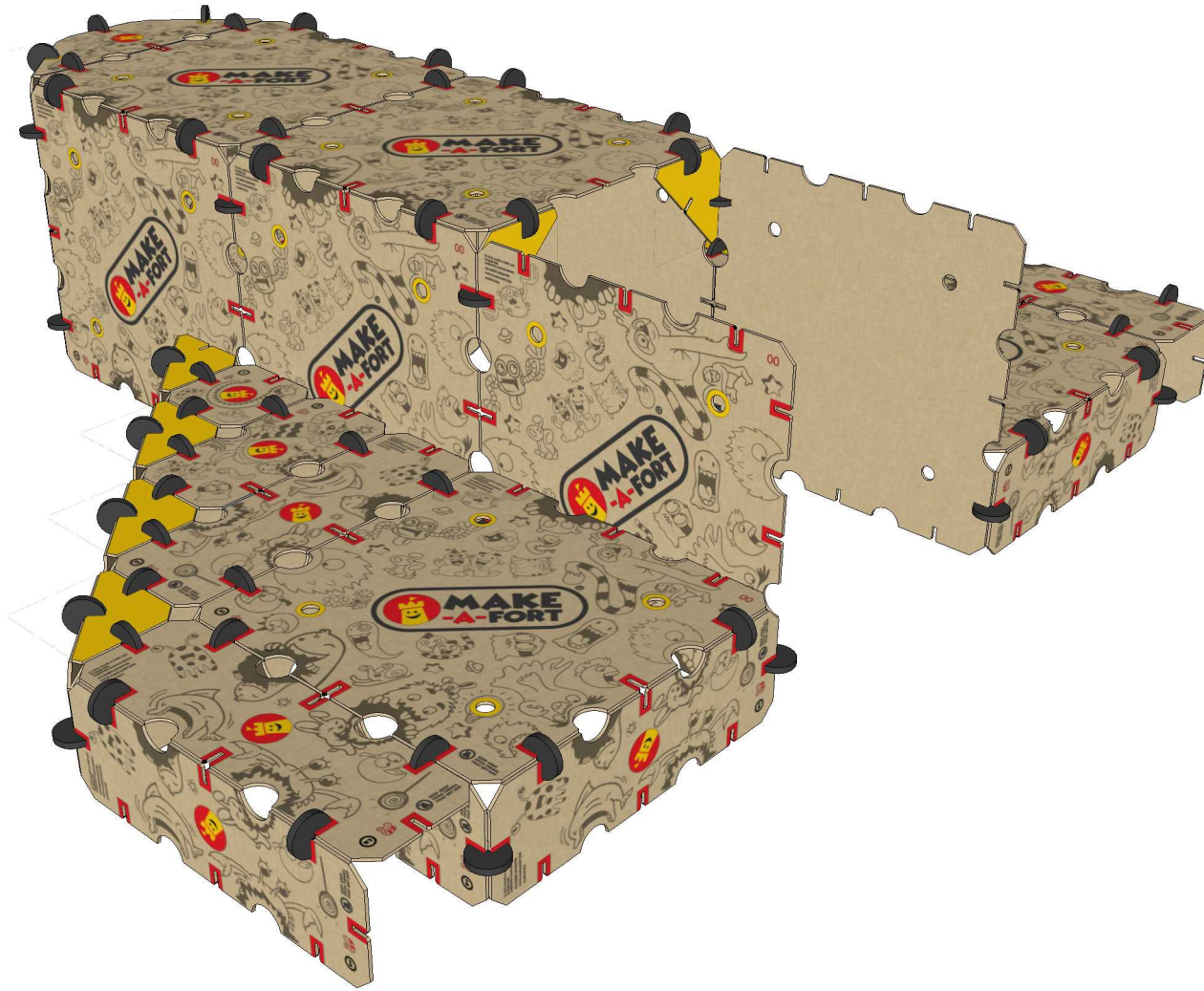

42

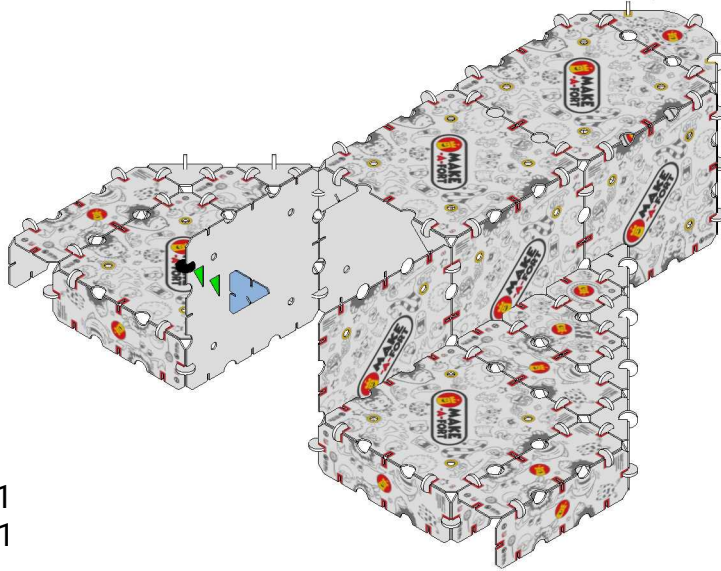

T x 1  
C x 1

43

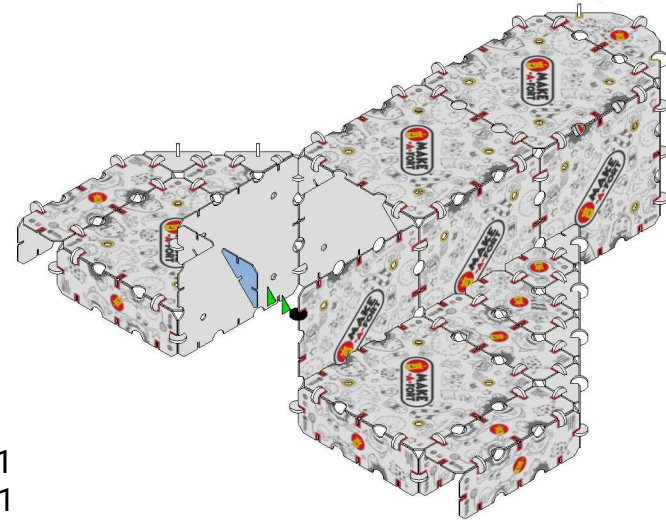

T x 1  
C x 1

44

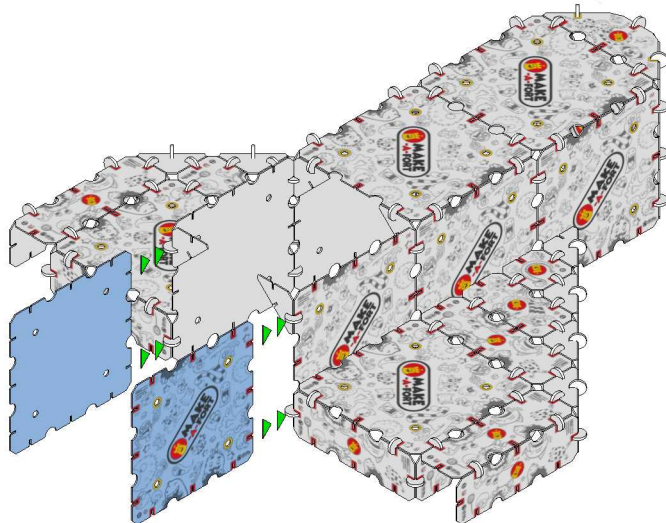

S3 x 2

45

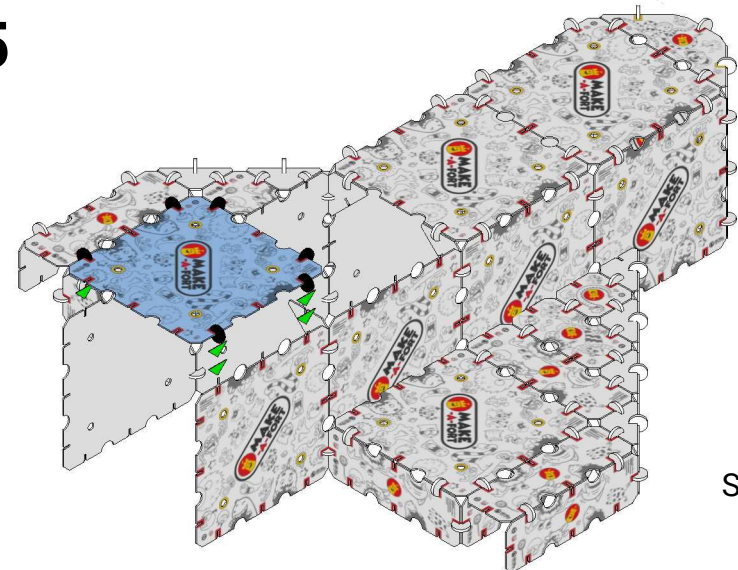

S3 x 1  
C x 6

46

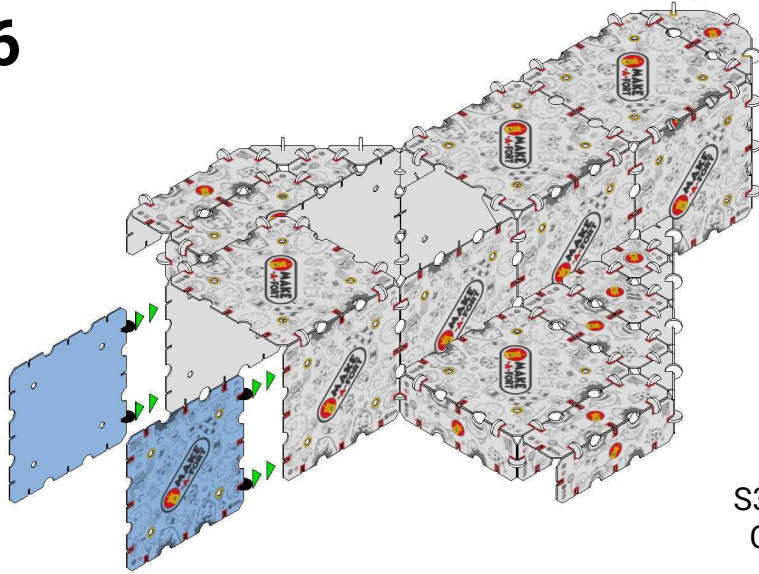

S3 x 2  
C x 4

47

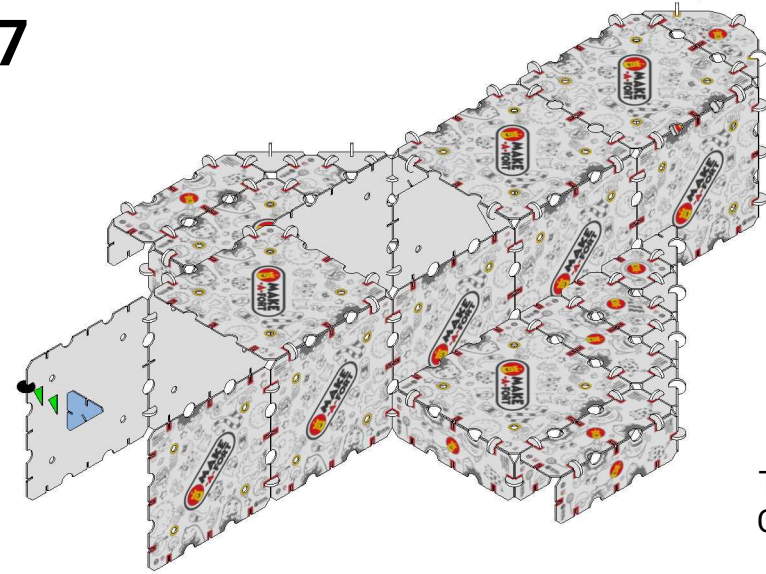

T x 1  
C x 1

48

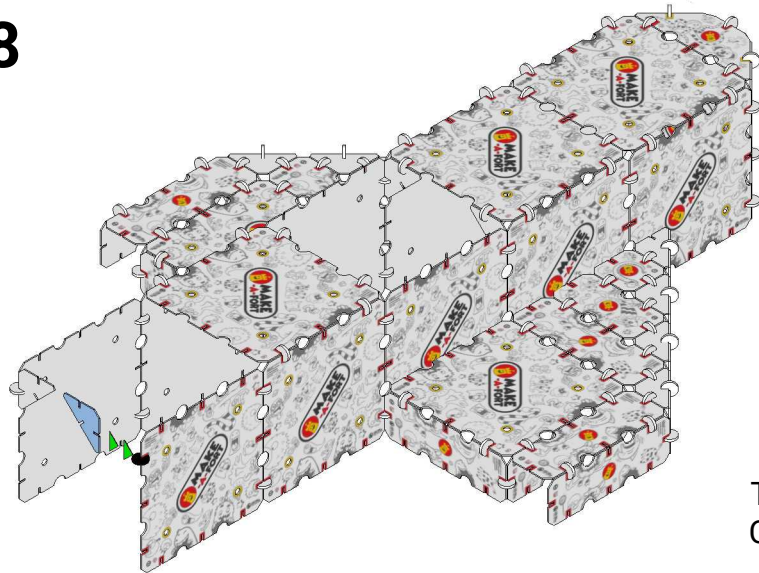

T x 1  
C x 1

49

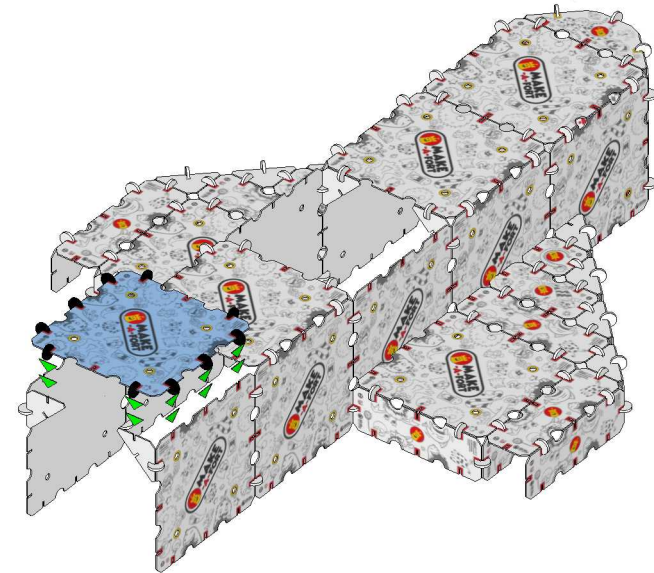

S3 x 1  
C x 10



# Project - Jet

## Build Rear Fuselage

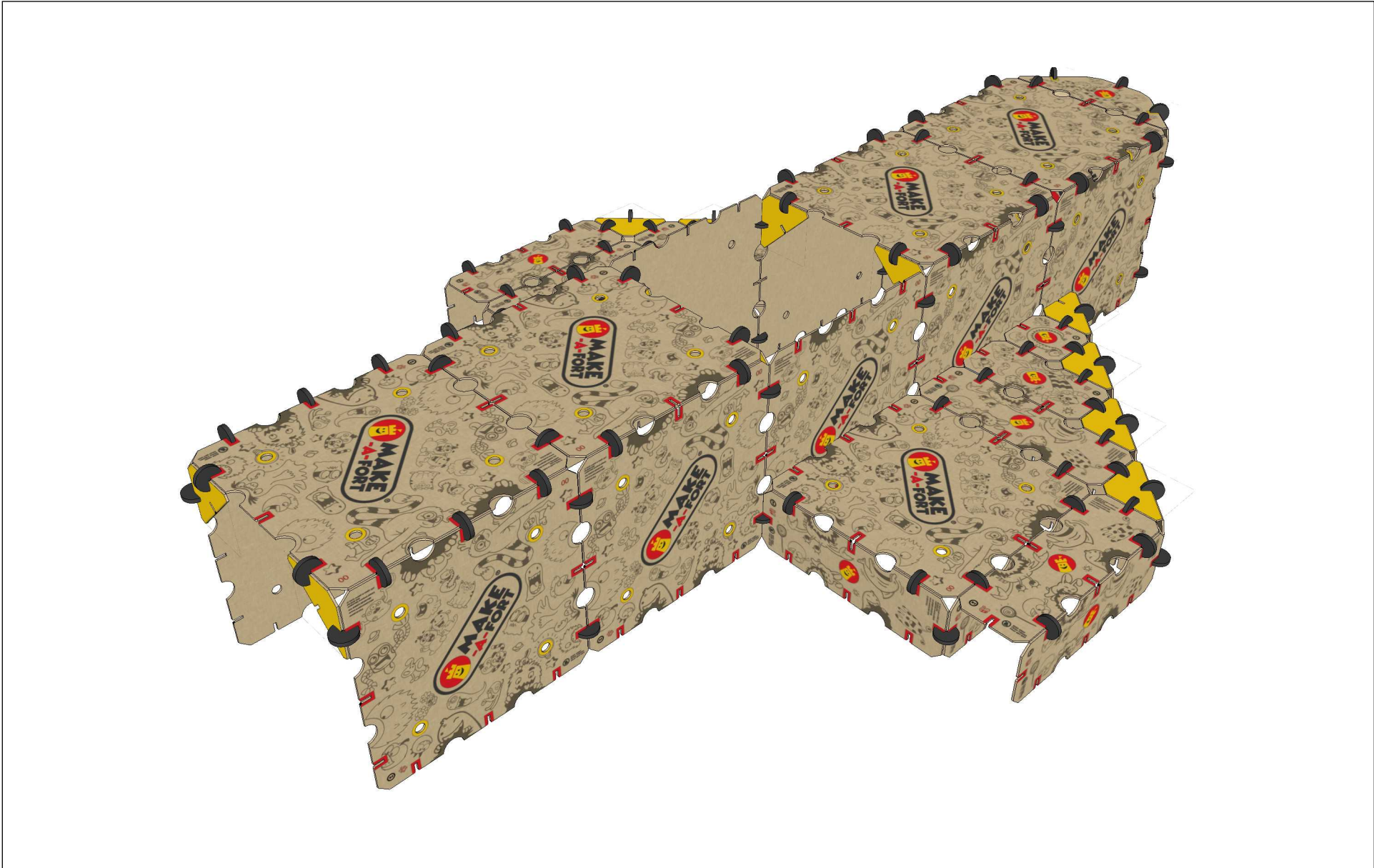

50

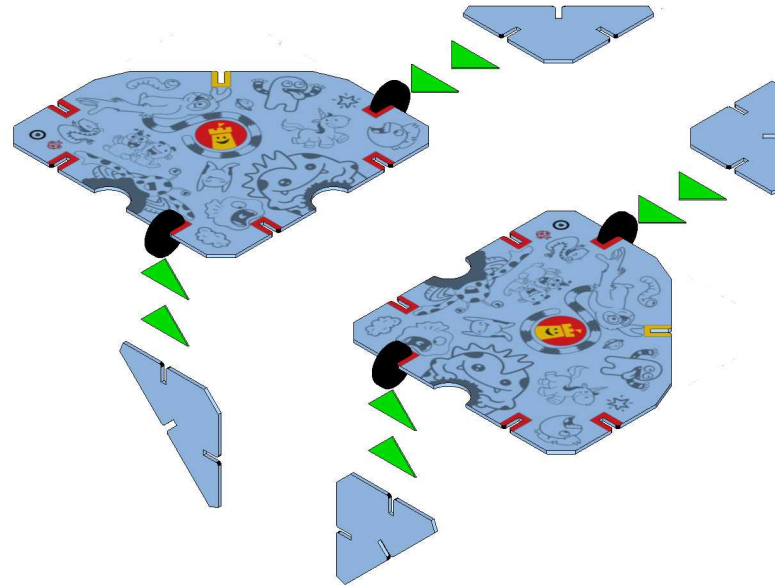

D x 2  
T x 4  
C x 4

51

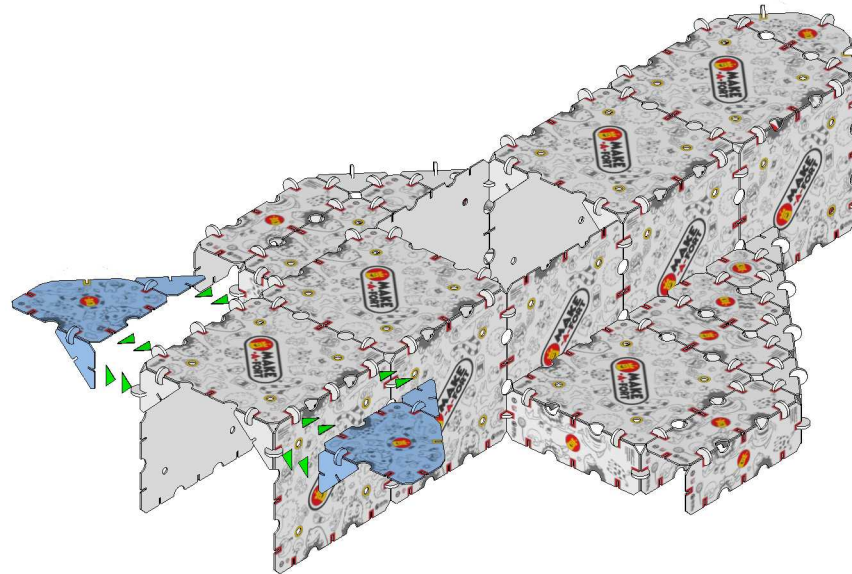



52

x 2

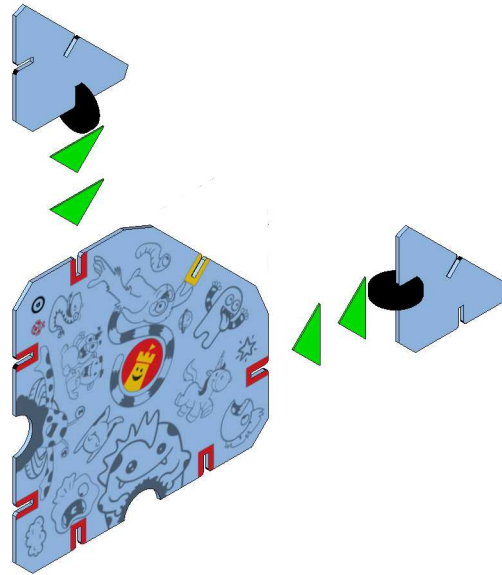

D x 2  
T x 4  
C x 4

53

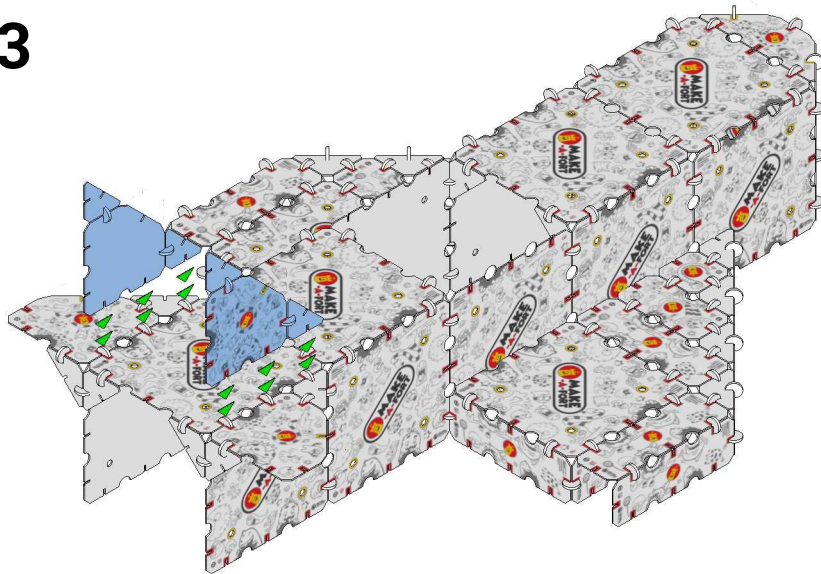

54

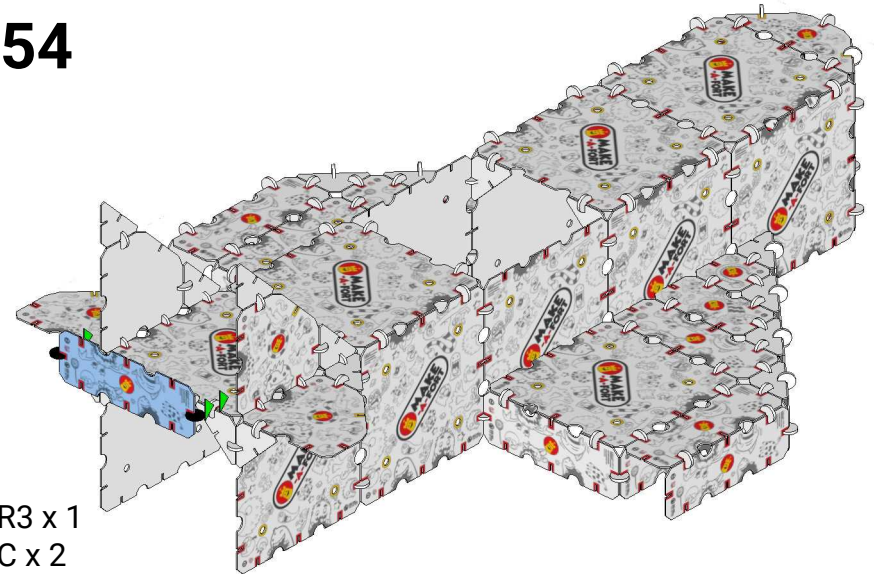

R3 x 1  
C x 2



# Project - Jet

## Build Tail

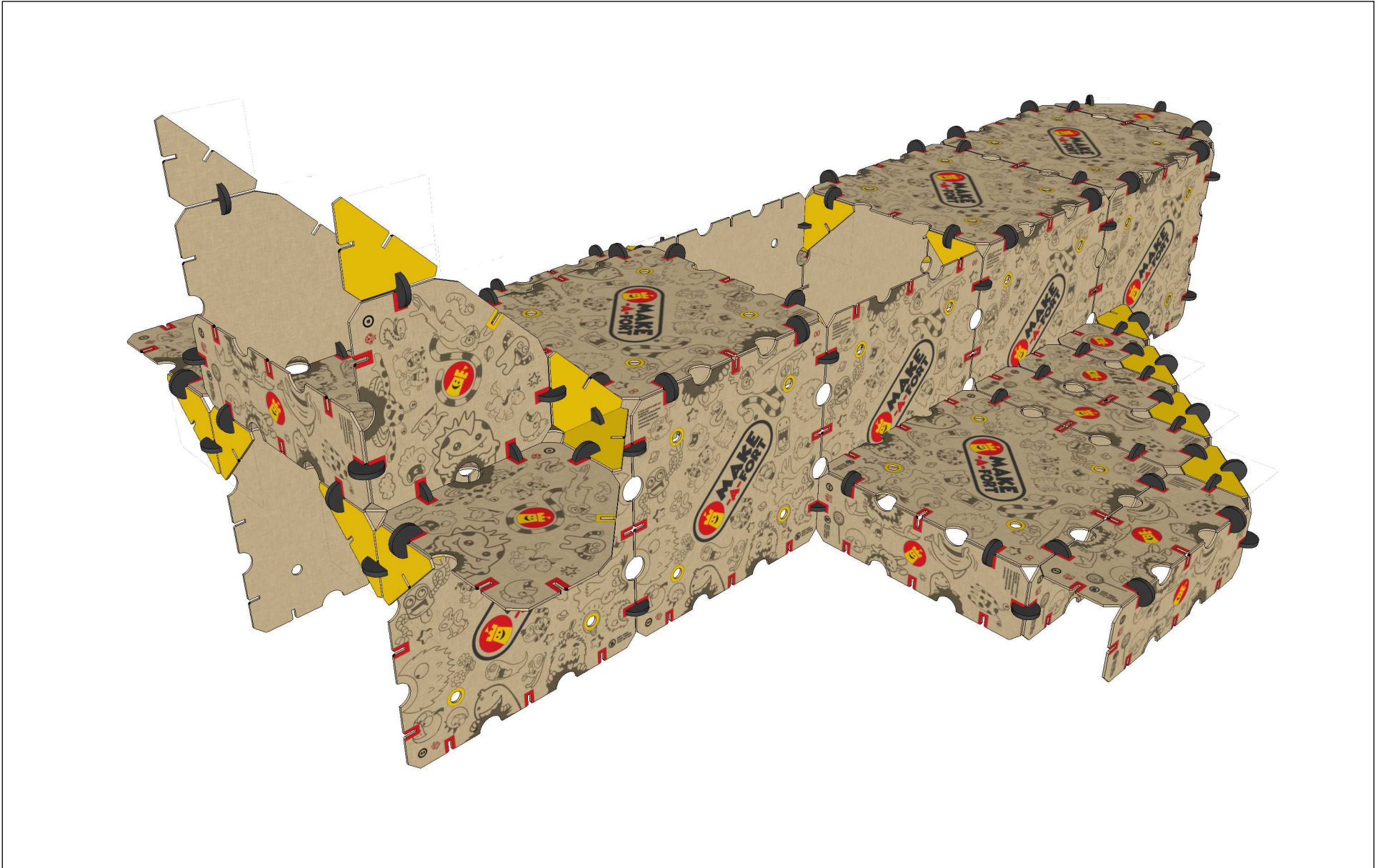

55

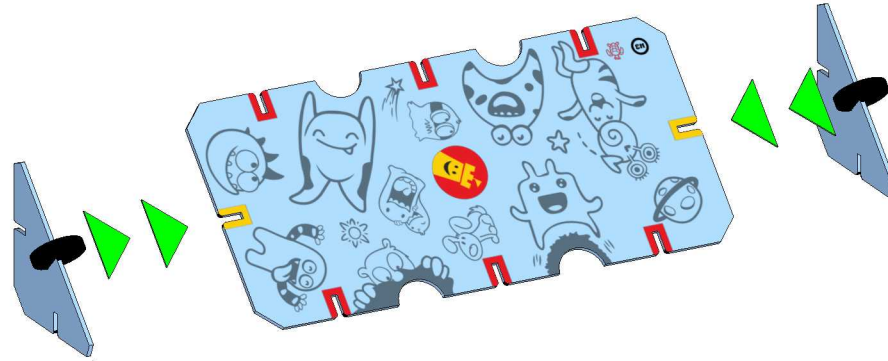

H3 x 1  
T x 2  
C x 2

56

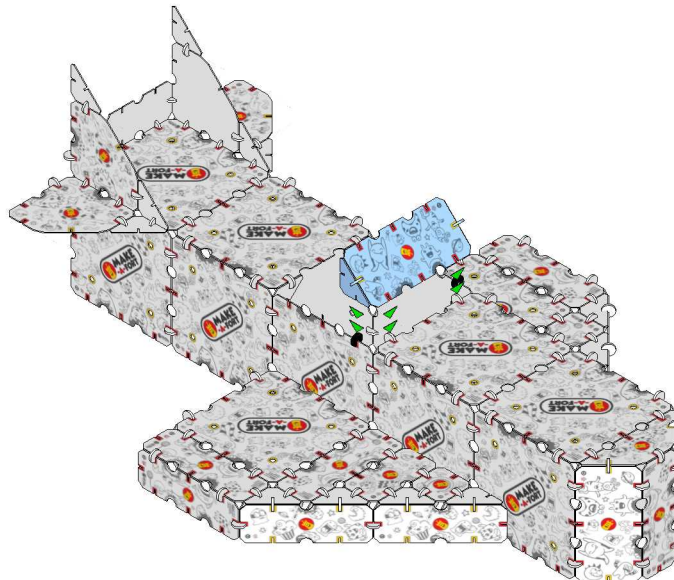

C x 2

57

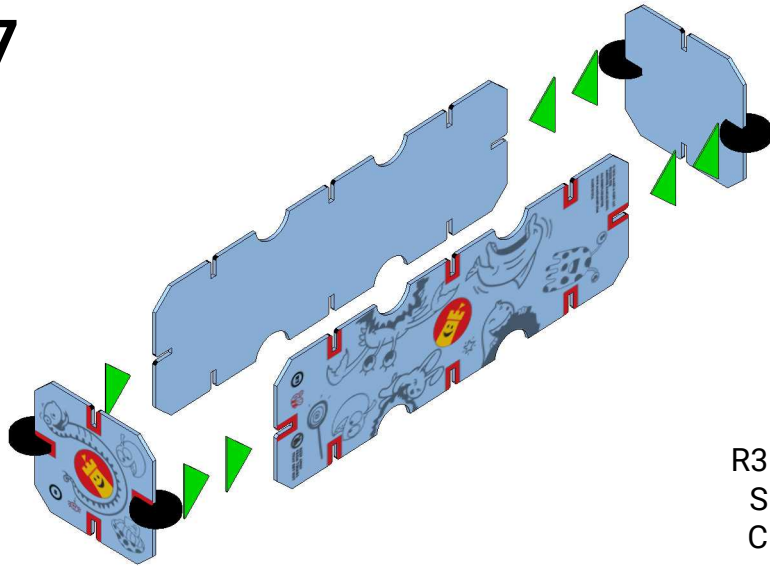

R3 x 2  
S x 2  
C x 4

58

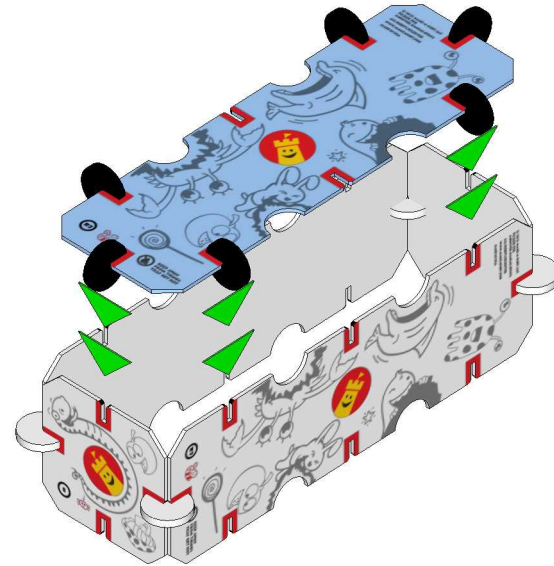

R3 x 1  
C x 6

59

